

SIVA's Ferro-MOM 7035 is a passive RAIN (UHF) RFID label for Mount on Metal applications delivered with a high performance permanent adhesive that bonds well with the metal surface it is mounted on. The label features a film face to print logos, product information, or scannable barcodes directly on the label.

Delivered with the Impinj Monza R6P chip, the label can also be customized to customer requirements on request. The label features a folded antenna design that delivers improved performance when the folded edge is mounted closer to the edge of the metal surface.

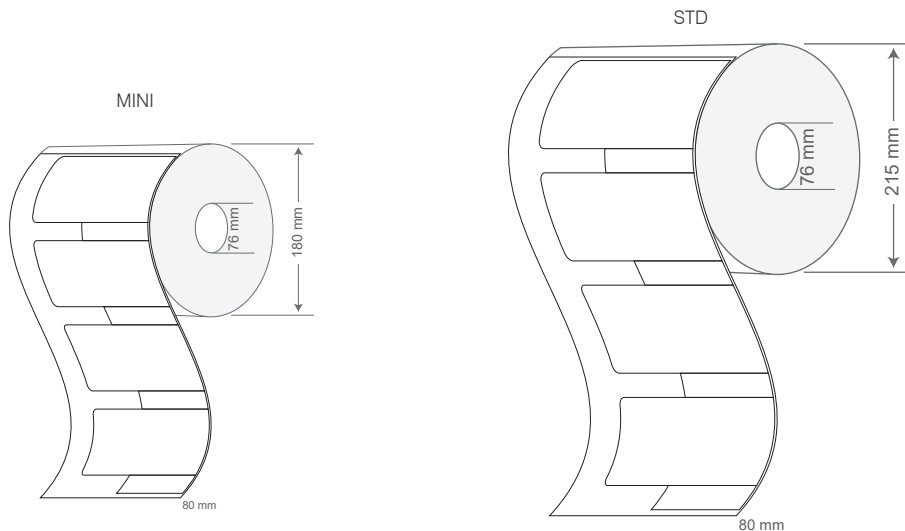

### PHYSICAL SPECIFICATION

Face Stock	Printable white PET , resin ribbon is recommended	
Label Sizes	70 x 35 x 2.2 mm 2.76 x 1.38 x 0.08 in	
Adhesive	High performance acrylic adhesive	
Weight	1.22 g	
Delivery format	Roll form	
No. of Labels/ Reel	std: 250 pcs	mini: 125 pcs
Label Pitch	45.72 mm / 1.8 in	
Core inner diameter	76 mm / 3 in	
Roll outer diameter	std: 215 mm / 8.46 in	mini: 180 mm / 7.08 in

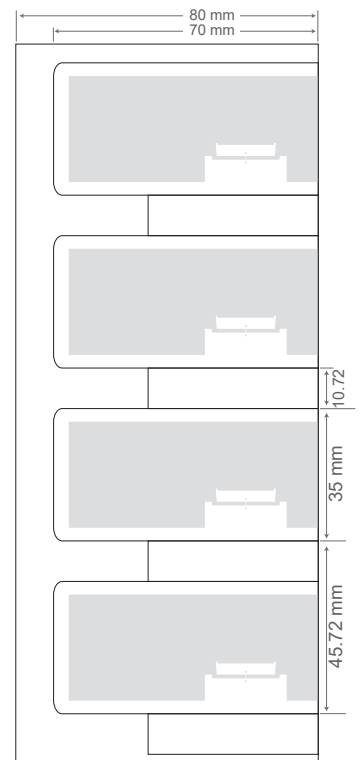

# RF SPECIFICATION

Mode of Operation	Passive
Device type	Class 1 Gen 2 Passive UHF RFID transponder
Air interface protocol	EPC Global Class 1 Gen 2 ISO 18000-6C
Operational frequency	ETSI: 865 - 869 MHz FCC: 902 - 928 MHz
IC type*	Impinj Monza R6P
Memory configuration	EPC Size of 96 - 128 Bits, 96 bits TID with 48 bits Unique serial number
Data Retention	Upto 50 years
Write Cycle Endurance	100,000
Applicable surface materials	All surfaces
Read Range**	ETSI: Metal- Upto 9m, PTFE- Upto 1.5m, Glass- Upto 4m FCC: Metal- Upto 10m, PTFE- Upto 4.5m, Glass- Upto 7m

# ENVIRONMENTAL RESISTANCE

Operating Temperature	-20°C to +70°C / -4°F to +158°F
Withstands Exposure to	95% humidity, 60°C × 100 h, 50% humidity, 80°C × 100 h
Peak Temperature	+80°C (Label remains securely attached with object. No physical or performance changes observed.)
Adhesive Service Temperature	-20°C to +70°C / -4°F to +158°F
Recommended Application Temperature	+10°C to +38°C / 50°F to +100.4°F
Water Resistance	IP68, tested for 5 hours in 1m deep water
Chemical Resistance	Resistant to chemical solvents and moisture
Ideal Storage Condition	+23°C / 50% RH
Expected Lifetime	Years in normal operating conditions

## PRODUCT INSTALLATION

Attach label in close proximity to edge of metal surface for optimum read range performance, as shown in image below.

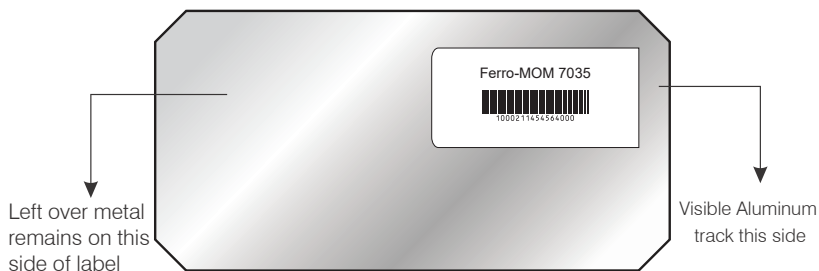

- Ensure the application surface is not uneven and is clean and dry, to obtain maximum bond strength. If required, use approved cleaning solvents to clean surface.
- Avoid touching the backside of the label while mounting it

## PERSONALIZATION OPTIONS

### Pre-encoding

- Customer specific encoding of EPC

### Customized Printing

- Customer specific layout including logo, text, numbers, barcodes etc.

## ORDER INFORMATION

### Part Number

- RF.LI.TT.MOM.7035.ETSI
- RF.LI.TT.MOM.7035.FCC

### Roll Sizes

- std: 250 Labels per Roll / 4 Rolls per Carton
- mini: 125 Labels per Roll

## PRINTER COMPATIBILITY

- Contact us for RFID printer compatibility and settings

# RADIATION PATTERN & READ RANGE GRAPH (ETSI & FCC)

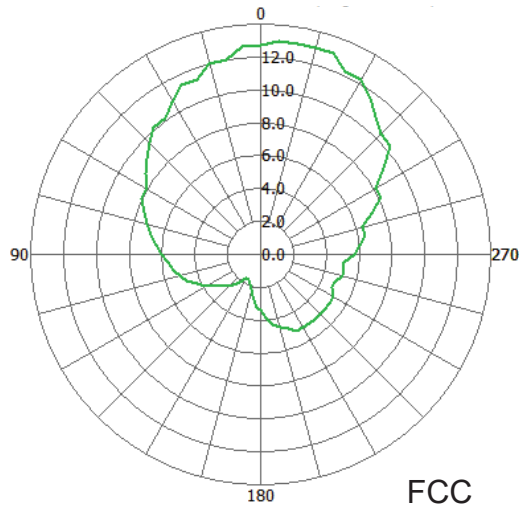
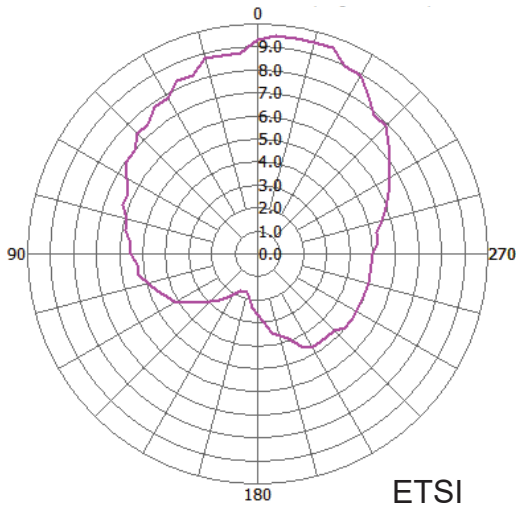

## ETSI

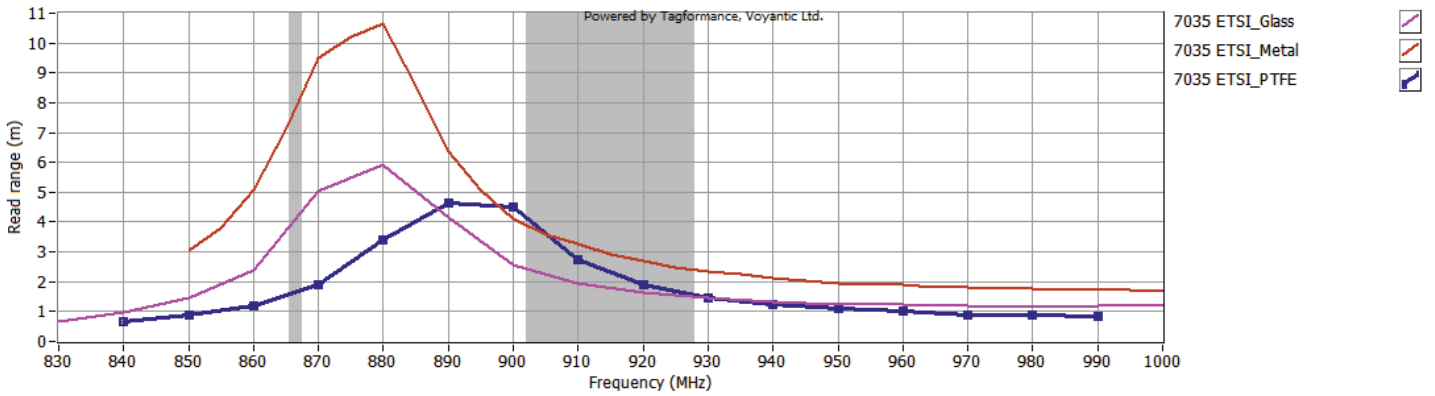

## FCC

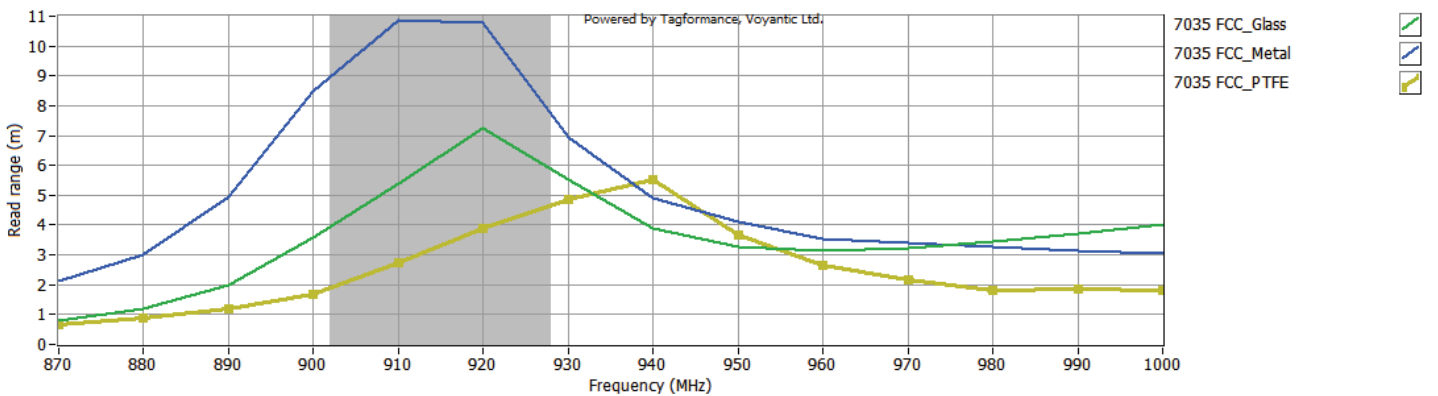

\* Other IC's available on request

\*\* The indicated read range values are measured in our laboratory testing environment, where antennas with optimum directivity are used with maximum allowed operating power. Different surface materials and environments may exhibit different results.



Version : 161121.01